

# XR942H

## PANORAMIC Light Reactive Welding and Grinding Helmet

### User Instructions



## 1. Introduction

Thank you for your purchase of the Parweld XR942H Welding Helmet. Please read and understand this instruction manual thoroughly to ensure correct, safe and effective use of the helmet. Failure to do so can result in serious injury. Keep this manual in a safe place for future reference.

## 2. Product Features

The XR942H uses a thin Liquid Crystal Display coupled to sensors react instantly to the arc being struck and switch the display to block the light before it is registered by the eye. The dark shade can be adjusted from 5-13 DIN depending upon the application. The lens system also includes permanent UV and IR filters which ensure full time protection for the user even in the light state or a failure mode. The helmet uses a true colour filter which improves the contrast and visibility especially with green LED's and the colours of the ARC are more realistic.

Working Temperature  
Range from -5 to +55°C.

Storage Temperature  
Range from -20 to +70°C.

Relative Humidity  
Range from 20% to 80%.

## 3. Technical Specifications and Parameters

View area (mm):	116 x 81
Shade Range	Clear state: DIN 3
	DIN 4-8, Step-less Adjustable
	DIN 9-14, Step-less Adjustable
Switching Time	1/30000s
Clearing Delay	0.04-2.0s, Adjustable
Sensitivity Control	0-9 Adjustable
Operation Mode	Weld, Grind, Cut
UV/IR Protection	DIN 16 Permanent
Alerts	ADF Self-check, Low Battery warning



## 4. Controls Location



External Control Pad

Internal cartridge controls

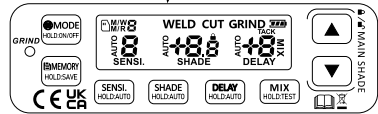

## 5. Adjustment to Suit Your Head

a) The helmet is provided with a range of adjustments to ensure a perfect fit on your head. Adjust the head band diameter, and the 3 over head bands so the lens is positioned in your normal line of sight.



## XR942H - PANORAMIC Light Reactive Welding and Grinding Helmet

b. Adjust the Distance Between Face and ADF, Using the two slider tabs, this will allow clearance for spectacles or face masks, ensure they are both set in the same position.

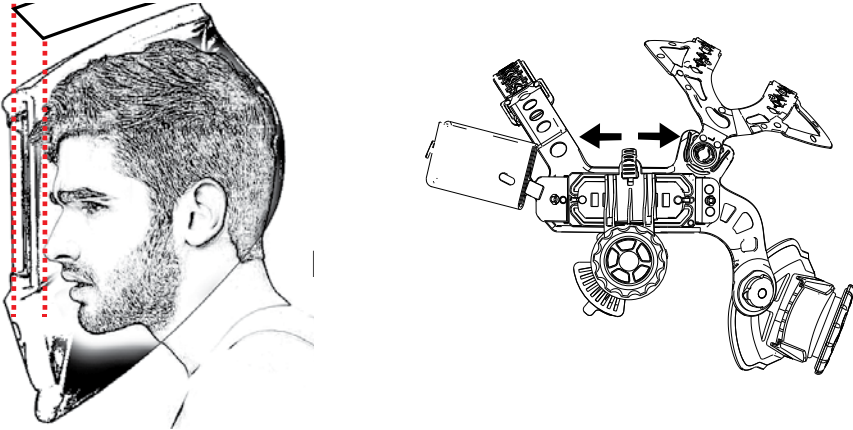

c. Adjust the rake rotation angle, this sets how far down the helmet sits in the down position depending on your working angle you will want to adjust this so the helmet sits close to your chest while maintaining the lens central to your vision. Adjust using the 2 tabs on the inside of the helmet at the pivot point.

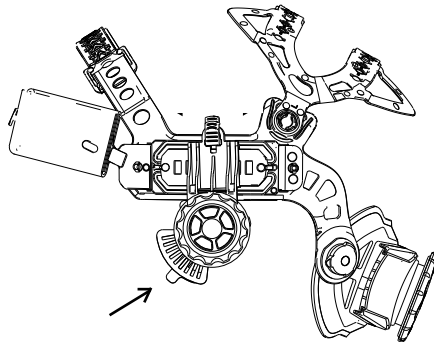

## 6. Operation

The XR942H can be operated in fully automatic mode or set manually, depending upon the application.

### Welding

Use mode button to toggle to welding mode (Internal or external)

### Shade adjustment

Internal quick press Shade button to make the shade flash up/down to adjust the shade External rotate the shade knob.

Automatic Shade control hold down Internal shade button for 2 seconds to switch on Auto mode External press the Mode button for 2 seconds. In Auto mode the helmet will select the correct shade when welding commences if you prefer lighter or darker than the automatic selection then you can trim the shade +/- by Internal, pressing the shade button briefly and then using the up/down arrow to trim. External rotate the shade knob

### HD Welding

Selecting shade 14 will activate HD welding which gives an extra dark lens for high power welding

### Locked shade

## Control View

### External

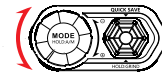
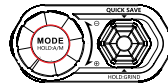
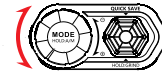
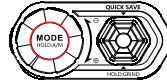

### Internal

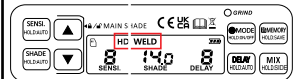
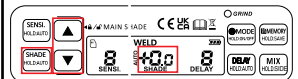
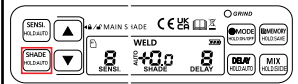
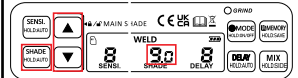
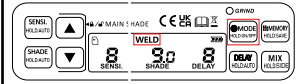

This locks the helmet in the dark state

## Internal

Toggle the Mode button until the padlock symbol is on, you can adjust the shade using the up down arrows.

## External

Toggle the Mode button until the padlock symbol is on, you can adjust the shade rotating the knob

## Sensitivity adjustment

Available in Weld and Cut modes, adjusts how sensitive the lens is to changes in light levels, as a general rule for low power welding use high sensitivity, for high power use lower sensitivity, if there is a lot of other light sources that cause the lens to darken then reduce sensitivity.

Internal quick press SENSI button to make the SENSI flash use up/ down to adjust the sensitivity.

Automatic sensitivity control hold down SENSI button for 2 seconds to switch on Auto mode in Auto mode the helmet will auto calibrate to the correct sensitivity level based on the ambient light conditions. (Auto calibration takes about 5 seconds)

## Control View

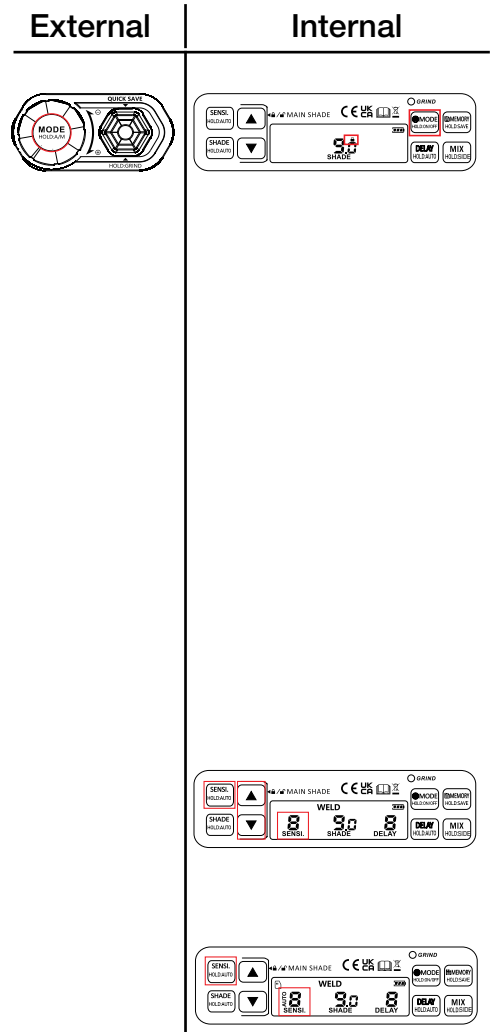

## Delay

This is the waiting time for the helmet to lighten after the welding process has finished. A longer delay is preferred for high power welding to reduce glass from the after glow.

## Internal

Internal quick press DELAY button to make the DELAY flash use up/ down to adjust the delay time.

Automatic delay control. Hold down DELAY button for 2 seconds to switch on Auto mode in Auto mode the helmet will auto calibrate to the correct delay level based on the shade selected and the light levels after the first weld. You +/- can trim the selected delay by briefly pressing the delay button and the using the Up down arrows

## TACK mode

A delay of 0 enables TACK mode which gives rapid lightening after each weld and the lens learns your working pattern

## MIX mode

Switching on the MIX mode reduces fatigue and eye strain by making the switch from dark to light a gradual transition rather than a switch from dark to light. MIX mode does not function with a DELAY of 0

## Internal

## Control View

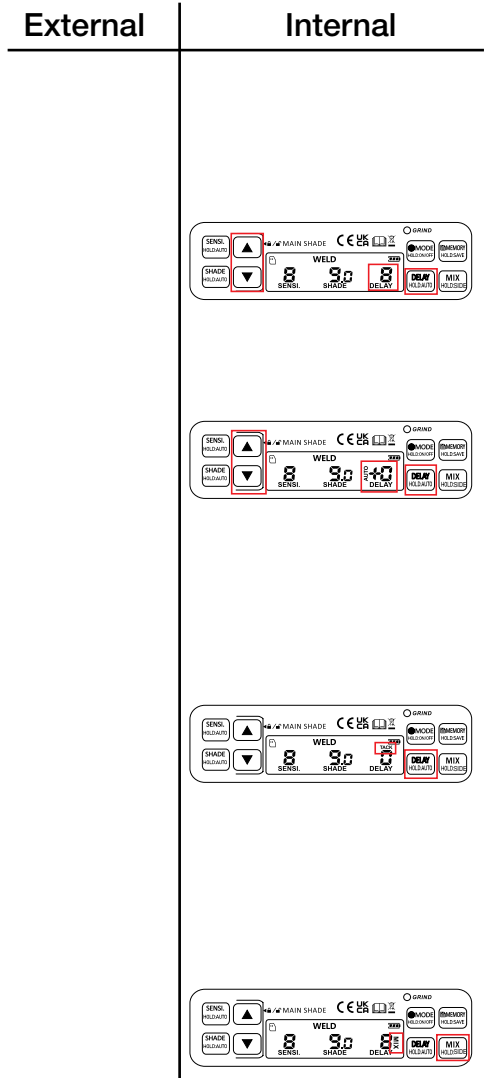

Briefly press the MIX button to switch on the MIX mode

## Side window lock

Locks the side windows in a dark state which is useful if you have someone working close by and don't want to be distracted by their arc light

Internal Press the MIX button for 2 seconds to lock the side windows to a dark state. Press again for 2 seconds to unlock works in WELD and CUT modes

## CUT mode

Use mode button to toggle to CUT mode (Internal or external)

In CUT mode the helmet shade can be adjusted from shade 4 to 8 which is more suitable for Plasma cutting applications.

Internal quick press Shade button to make the shade flash up/ down to adjust the shade External rotate the shade knob.

In CUT mode SENSI and DELAY work as in WELDING mode Other functions are disabled.

## Control View

### External

### Internal

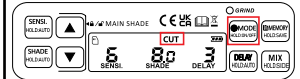
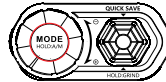
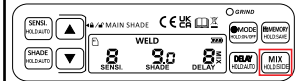
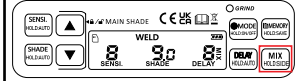



## GRIND mode

Internal use mode button to toggle to GRIND mode

External, press the hex button for 2 seconds

The grind LED will flash to indicate grind mode is activated and the lens will be locked in shade 3 Please the hex or mode button to return to normal operation.

## Memory

the memory function allows the storage of regularly used settings for different jobs. There are 10 memory locations that can be used to save to

### External

#### Quick save function

Once you are happy with the settings briefly press the hex button, which will save the settings to quick save memory location 0. To recall from the quick save location Briefly press the internal MEMORY button so that the memory number is flashing and the press the MEMORY button again for 2 seconds which will recall the contents of the Quick save memory location 0.

Internal,

## Control View

### External

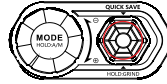

### Internal

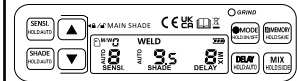
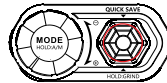
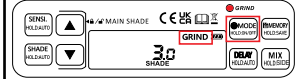

# XR942H - PANORAMIC Light Reactive Welding and Grinding Helmet

Short press the memory button will recall the next memory location. Using the up down arrows you can change the memory location to recall any stored setting. (M/R)

If you wish to save to memory after adjusting the setting long press the memory button to call up the memory locations, select the required memory location using the up down arrows and the parameters will save after a few seconds (M/W)

## Power On Off

When not in use you should power off the unit using the MODE button (Internal)

Press the internal mode button for 2 seconds to power off the unit

To power on press the internal mode button until the display lights up. the unit will perform a self test to ensure the lens darkens.

## Control View

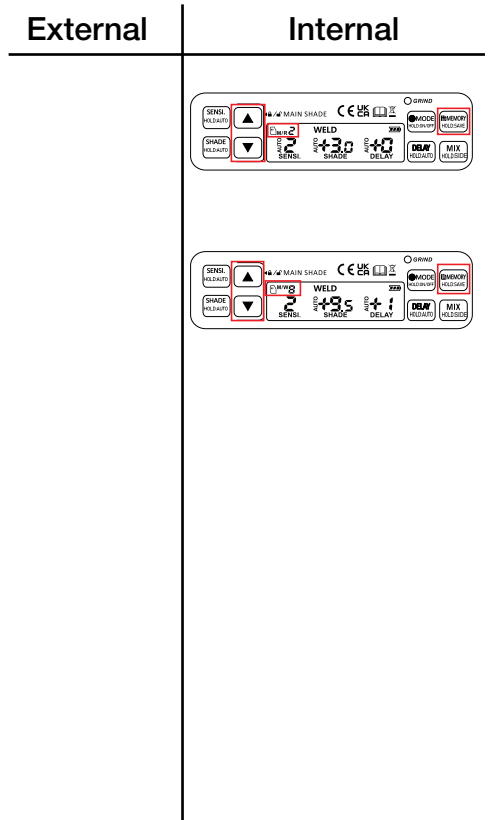

## Battery

The lens has an internal replaceable battery. Battery replacement is required when the battery symbol starts to flash. Pull out the battery tray noting the orientation of the tab. remove the two old batteries and replace with the same type CR2032. pay attention to the + symbol on the batteries and the holder. Reinsert the holder with the tab facing up

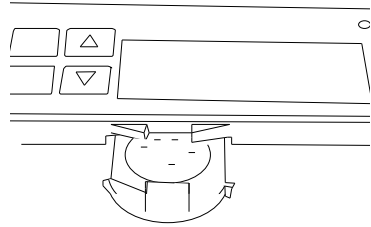

## Protective cover lens replacement

Never use the welding helmet without a protective cover lens fitted internally and externally. Failure to do so will invalidate the warranty.

### Front cover lens removal

Hold the helmet by the rear edge and use 2 fingers to un-clip the lens with a peeling action.

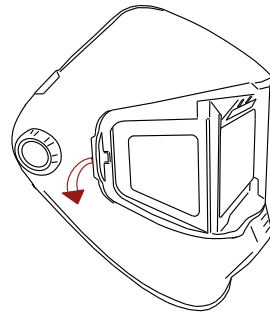

## Refitting

Locate the outer edge of the lens on one of the side tabs and then using two fingers trace round the outside of the lens ensuring that the top and bottom edges are properly located. Finally whilst supporting the helmet on the inside with one hand, starting in the middle of the lens using the other hand apply sliding pressure as you move around to the unclipped end. The lens will clip into place.

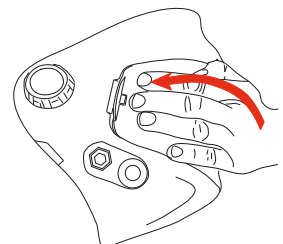
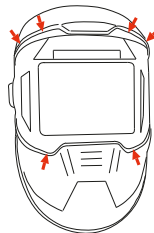

## Internal cover lens

Flex the lens by inserting a finger nail into the slot at the top of the lens, ensure it engages under the tabs indicated.

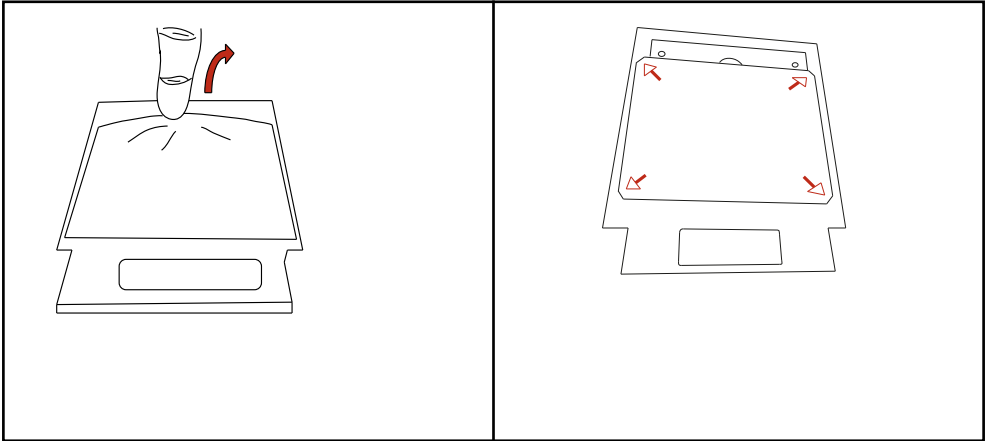

## Side window Cover lens

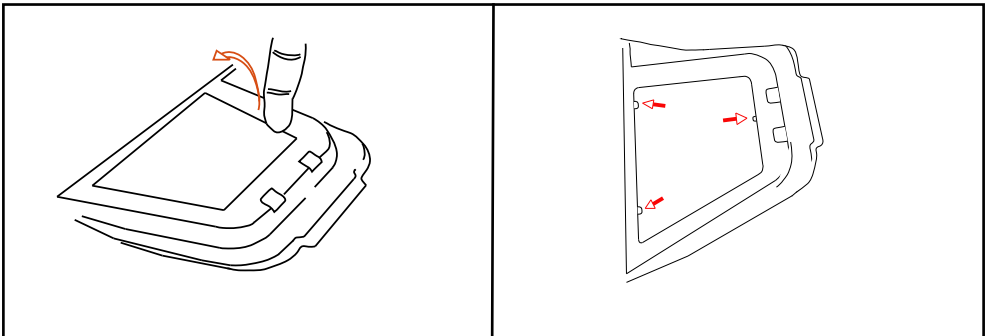

## 7. Maintenance

### Foam headband removal

- Pull the head band slightly left and right to release from the locating pins and un wrap from the head band. The foam head band can be hand washed in a mild detergent, replacement is the opposite of removal.
- Trouble shooting

Fault	Cause	Solution
Irregular shading across the lens	Uneven adjustment of the head band meaning one eye is close than the other to the lens	Reset head band adjustment so it is symmetrical
Filter flickering or fails to darken	Cover lens is dirty Sensors are dirty View of the weld is obscured Sensitivity is too low	Clean or replace the cover lens Clean the sensors with a lint free cloth Ensure a clear view of the welding arc Increase sensitivity setting

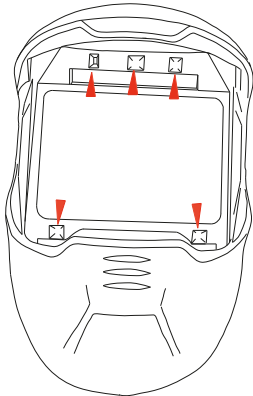

Sensor location

## Recommended Shade Numbers

WELDING PROCESS	CURRENT AMPERES																						
	0.5	1	2.5	5	10	15	20	30	40	60	80	100	125	150	175	200	225	250	275	300	350	400	450
Covered Electrodes	Shade 9									10	Shade 11						Shade 12			Shade 13		14	
MIG Plate Welding	Shade 10									Shade 11			Shade 12			Shade 13			14				
MIG Sheet Welding	Shade 10									Shade 11			Shade 12		Shade 13		Shade 14		15				
TIG	Shade 9				10	Shade 11				Shade 12		Shade 13		Shade 14									
MAG	Shade 10						11	12		Shade 13			Shade 14		Shade 15								
Arc Gouging	Shade 10										11	12		13		14		Shade 15					
Plasma Cutting	Shade 11										Shade 12			Shade 13									
Plasma Welding	4	5	6	7	8	9	10	11	Shade 12		Shade 13			Shade 14			Shade 15						

## 8. Warranty

The manufacturer provides a warranty of 36 months from invoice date for all manufacturing defects. The warranty becomes void if not operated according to the instruction manual. The warranty becomes void if the helmet has been modified in any way. for warranty service please return to the point of purchase

- Switch off the helmet is not in use
- Storage temperature range is -20°C ~ 70°C.

## 9. Storage

## 10. Parts List

Item	Description	Part No
1	Front Cover Lens (5pcs)	XR443
2	Auto-Darkening Filter (ADF)	XR352
3	Side Window cover lens (pair)	XR445
4	Inside Cover Lens (10pcs)	XR444
5	Headband Assembly	XR342
6	Sweatband	XR372
7	Battery :- Battery Type (single)	XR363
8	Hand nuts (pair)	XR373

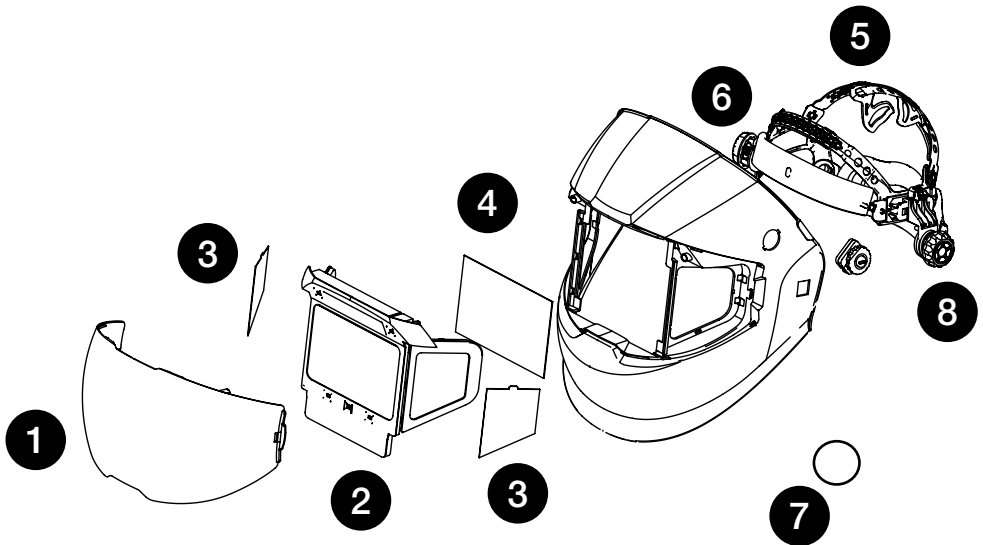



[parweld.com](http://parweld.com)



[@ParweldLtd](https://twitter.com/ParweldLtd)



[ParweldTV](https://www.youtube.com/ParweldTV)



[parweld\\_uk](https://www.instagram.com/parweld_uk)

## **PARWELD LIMITED**

Bewdley Business Park, Long Bank,  
Bewdley, Worcestershire, DY12 2TZ

**T +44 (0) 1299 266 800**

**UK AND IRELAND SALES +44 (0) 1299 269 500**

**EXPORT SALES +44 (0) 1299 269 507**

**E [info@parweld.co.uk](mailto:info@parweld.co.uk) [www.parweld.com](http://www.parweld.com)**