



XTM 405i

XTM 505i

OPERATOR MANUAL

ISSUE 1

Welcome

Thank you and congratulations on choosing Parweld. This Owner's Manual is designed to help you get the most out of your Parweld products. Please take time to read the Safety precautions. They will help you protect yourself against potential hazards in the workplace. With proper maintenance this equipment should provide years of reliable service. All our systems conform to ISO9001: 2015 and are independently audited by NQA.

The entire product range carries the CE and UKCA mark, and is constructed in accordance with European and UK directives and the product specific standards where they apply.

Further Information

Parweld is the UK's leading manufacturer of equipment for MIG, TIG and Plasma processes and consumables.

For more information about Parweld's complete range visit: www.parweld.co.uk



parweld.com



[@ParweldLtd](https://twitter.com/ParweldLtd)



[ParweldTV](https://www.youtube.com/ParweldTV)



[parweld_uk](https://www.instagram.com/parweld_uk)

Contents

Welcome	2	9.2 Torch Schematic - PRO440W.....	22
Further Information	2		
1.0 Safety Precautions	4	10.0 EC Declaration of Conformity.....	23
2.0 Product Description	5	10.1 RoHS Compliance Declaration	23
3.0 Technical Specifications	5	10.2 WEEE Statement.....	24
4.0 Machine Overview	6	10.3 Statement of warranty.....	24
4.1 Description of Controls Front.....	7		
4.1 Description of Controls Back	8		
5.0 Installation.....	9		
5.1 Unpacking the Machine.....	9		
5.2 Location.....	9		
5.3 Input and Grounding Connection	9		
5.4 MIG Welding Torch Setup.....	9		
5.4.1 Changing Feed Roll Sets	9		
5.4.2 Welding Wire Installation	9		
5.4.3 Torch Installation	9		
5.4.4 Work Return Lead Connection	10		
5.4.5 Shielding Gas Connection	10		
6.0 Setup for Welding	10		
6.1 MIG Welding.....	10		
6.1.1 Synergic MIG Welding	10		
6.1.2 Manual Welding	11		
6.1.3 Feeding Wire Electrode.....	12		
6.1.4 Optimising Weld Parameters (Manual Mode)	12		
6.1.5 Optimising Weld Parameter (Synergic Mode).....	12		
6.1.6 Burn Back.....	12		
6.1.7 Post Gas Setting	12		
6.1.8 Aluminium Welding.....	12		
6.1.9 Trigger Control 2T /4T	12		
6.2 MMA Welding	12		
6.2.1 Torch and Work Lead Conenctions	12		
6.2.2 Operation.....	12		
6.2.3 Arc Force.....	12		
6.3 TIG Welding Operation.....	12		
7.0 Fault Finding	13		
7.1 MIG Fault Finding	13		
7.2 MMA Fault Finding.....	15		
7.3 TIG Fault Finding	15		
7.4 Power Source Fault Finding	16		
8.0 Accessories.....	18		
8.1 Feed Rolls	18		
8.2 Torch Spares	18		
8.3 Gas Equipment.....	18		
8.4 Flow Meters.....	18		
9.0 Torch Schematic - XP8 400A.....	19		
9.1 Torch Schematic - XP8 450W.....	20		

1.0 Safety Precautions

ELECTRIC SHOCK can kill.

Touching live electrical parts can cause fatal shocks or severe burns. The electrode and work circuit is electrically live whenever the output is on. The input power circuit and machine internal circuits are also live when power is on.

Do not touch live electrical parts.

Wear dry, sound insulating gloves and body protection.

Insulate yourself from work and ground using dry insulating mats or covers big enough to prevent any physical contact with the work or ground.

Additional safety precautions are required when any of the following electrically hazardous conditions are present: in damp locations or while wearing wet clothing; on metal structures such as floors, gratings, or scaffolds; when in cramped positions such as sitting, kneeling, or lying; or when there is a high risk of unavoidable or accidental contact with the work piece or ground.

Disconnect input power before installing or servicing this equipment. Lockout/tagout input power according to Safety Standards.

Properly install and ground this equipment according to national and local standards.

Always verify the supply ground - check and ensure that input power cable ground wire is properly connected to ground terminal in the receptacle outlet.

When making input connections, attach proper grounding conductor first - double-check connections.

Frequently inspect input power cable for damage or bare wiring - replace cable immediately if damaged - bare wiring can kill.

Turn off all equipment when not in use.

Do not use worn, damaged, under sized, or poorly spliced cables.

Do not drape cables over your body.

If earth grounding of the work piece is required, ground it directly with a separate cable.

Do not touch electrode if you are in contact with the work, ground, or another electrode from a different machine.

Use only well-maintained equipment. Repair or replace damaged parts at once. Maintain unit according to manual.

Wear a safety harness if working above floor level.

Keep all panels and covers securely in place.

Clamp work cable with good metal-to-metal contact to work piece or worktable as near the weld as practical.

Insulate work clamp when not connected to work piece to prevent contact with any metal object.

Welding produces fumes and gases. Breathing these fumes and gases can be hazardous to your health.

FUMES AND GASES can be hazardous.

Keep your head out of the fumes. Do not breathe the fumes. Ventilate the area and use local forced ventilation at the arc to remove welding fumes and gases or, wear an approved respirator.

Read and understand the Material Safety Data Sheets (MSDS's) and the manufacturer's instructions for metals, consumable, coatings, cleaners, and de-greasers.

Work in a confined space only if it is well ventilated, or while wearing an air-supplied respirator. Always have a trained watch person nearby. Welding fumes and gases can displace air and lower the oxygen level causing injury or death. Be sure the breathing air is safe.

Do not weld in locations near de-greasing, cleaning, or spraying operations. The heat and rays of the arc can react with vapours to form highly toxic and irritating gases.

Do not weld on coated metals, such as galvanized, lead, or cadmium plated steel, unless the coating is removed from the weld area, the area is well ventilated, and while wearing an air-supplied respirator. The coatings and any metals containing these elements can give off toxic fumes if welded.

ARC RAYS can burn eyes and skin.

ARC rays from the welding process produce intense, visible and invisible (ultraviolet and infrared) rays that can burn eyes and skin. Sparks fly off from the weld.

Wear an approved welding helmet fitted with a proper shade of filter lense to protect your face and eyes when welding or watching

Wear approved safety glasses with side shields under your helmet.

Use protective screens or barriers to protect others from flash, glare and sparks; warn others not to watch the arc.

Wear protective clothing made from durable, flame resistant material (leather, heavy cotton, or wool) and foot protection. Welding on closed containers, such as tanks, drums, or pipes, can cause them to blow up. Sparks can fly off from the welding arc. The flying sparks, hot work piece, and hot equipment can cause fires and burns. Accidental contact of electrode to metal objects can cause sparks, explosion, overheating, or fire. Check and be sure the area is safe before doing any welding.

WELDING can cause fire or explosion.

Remove all flammables within 10m of the welding arc. If this is not possible, tightly cover them with approved covers.

Do not weld where flying sparks can strike flammable material.

Protect yourself and others from flying sparks and hot metal.

Be alert that welding sparks and hot materials from welding can easily go through small cracks and openings to adjacent areas.

Watch for fire, and keep a fire extinguisher nearby. Be aware that

welding on a ceiling, floor, bulkhead, or partition can cause fire on the hidden side.

Do not weld on closed containers such as tanks, drums, or pipes, unless they are properly prepared according to local regulations.

Connect work cable to the work as close to the welding area as practical to prevent welding current from travelling along, possibly unknown paths and causing electric shock, sparks, and fire hazards.

Wear oil-free protective garments such as leather gloves, heavy shirt, cuffless trousers, high shoes, and a cap. Remove any combustibles, such as a butane lighter or matches, from your person before doing any welding.

FLYING METAL can injure eyes.

Welding, chipping, wire brushing, and grinding cause sparks and flying metal. As welds cool they can throw off slag. Wear approved safety glasses with side shields even under your welding helmet.

BUILDUP OF GAS can injure or kill.

Shut off shielding gas supply when not in use. Always ventilate confined spaces or use approved air-supplied respirator.

HOT PARTS can cause severe burns.

Do not touch hot parts with bare hands.

Allow cooling period before working on gun or torch.

To handle hot parts, use proper tools and/or wear heavy, insulated welding gloves and clothing to prevent burns.

MAGNETIC FIELDS can affect pacemakers.

Pacemaker wearers keep away.

Wearers should consult their doctor before going near arc welding, gouging, or spot welding operations.

NOISE can damage hearing.

Noise from some processes or equipment can damage hearing.

Wear approved ear protection if noise level is high.

Shielding gas cylinders contain gas under high pressure.

CYLINDERS can explode if damaged.

Protect compressed gas cylinders from excessive heat, mechanical shocks, physical damage, slag, open flames, sparks, and arcs. Install cylinders in an upright position by securing to a stationary support or cylinder rack to prevent falling or tipping. Keep cylinders away from any welding or other electrical circuits. Never drape a welding torch over a gas cylinder. Never allow a welding electrode to touch any cylinder. Never weld on a pressurized cylinder - explosion will result. Use only correct shielding gas cylinders, regulators, hoses, and fittings designed for the specific application; maintain them and associated parts in good condition.

Turn face away from valve outlet when opening cylinder valve.

Use the right equipment, correct procedures, and sufficient number of persons to lift and move cylinders.

Read and follow instructions on compressed gas cylinders, associated equipment, and Compressed Gas Association (CGA) recommendations.

2.0 Product Description

This welding machine is manufactured using advanced inverter technology. The input voltage is rectified to DC and then inverted to high frequency AC voltage before being converted back to DC for the output. This allows the use of a much smaller transformer and so allowing weight saving and improved power efficiency.

3.0 Technical Specifications

Model	XTM405i	XTM505i
Input Voltage (V)	400V 3P	400V 3P
Frequency	50/60Hz	50/60Hz
Input Current A (MAX)	22.8A	36.9A
Input Current A (Eff)	21.2A	26.4A
Fuse rating	32A	32A
Output OCV	60V	60V
Output load Voltage	15-34V	15-39V
Rated Power (KW)	16.4	22.7
Recommended Generator (KVA)	25	30
Efficiency (%)	88	88
Power Factor	0.68	0.68
Insulation class	F	F

Duty Cycle	XTM405i	XTM505i
60%	400A	500A
100%	312A	390A

4.0 Machine Overview



1. Power Source
2. Wire Feeder
3. Water Cooler (Optional)
4. Trolley
5. Interconnecting Cables

4.1 Description of Controls Front

Power Source



Wire Feeder



6. Amperage Display. Displays the welding amperage during welding.

7. Voltage Display. Displays the welding voltage during welding

8. Fault indicator light, illuminates if the machine is over temperature or in a fault condition

9. Power Indicator shows when the machine is turned on.

10. Process Sector MIG, MMA or TIG. In MIG mode controls are transferred to the wire feeder, in TIG or MMA all controls are on the power source front panel.

11. Amperage control for adjusting the Amperage in TIG or MMA mode

12. Voltage control This function controls the inductance

during MIG welding and the Arc force during MMA welding.

13. Positive Output Connection for MMA electrode holder or TIG work return lead. This is a 50mm twist lock connection.

14. Negative output connection used to connect the work return lead for MIG or MMA and the TIG torch power cable. This is a 50mm twist lock connection.

15. Voltage Trim, used to trim the voltage +/- during synergic welding or to set the welding voltage during manual MIG welding

16. Wire speed/Amperage control, used to set the wire speed during Manual welding or to trim the wire speed during synergic welding.

17. Memory button used to save MIG settings

18. Step back button to return to previous menu.

19. Main function adjustment button used to navigate through the menus by rotating and pushing. Short press selects an option, long press goes back to home menu

20. Euro torch connection for MIG torch

21. Gas test button to check gas flow

22. Wire inching button for wire loading.

23. Water in out connections used for water cooled torch.

4.1 Description of Controls Back



- 24. Main Power switch.
- 25. Input power cable L1,L2,L3 +PE
- 26. Connection for wire feeder control
- 27. Welding Power output for connection to wire feeder
- 28. Power outlet for watercooler (400V)
- 29. Wire tension adjusters
- 30. feed rolls

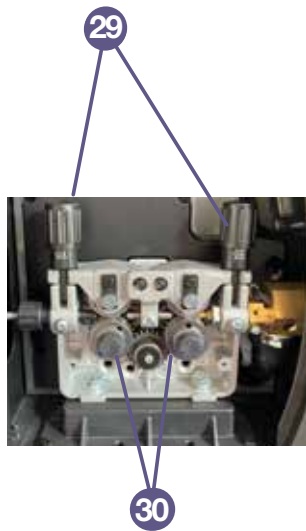

5.0 Installation

Read entire installation section before starting installation.

SAFETY PRECAUTIONS

- **ELECTRIC SHOCK can kill.**
- **Only qualified personnel should perform this installation.**
- **Only personnel that have read and understood the Operating Manual should install and operate this equipment.**
- **Machine must be grounded per any national, local or other applicable electrical regulations.**
- **The power switch is to be in the OFF position when installing work cable and electrode cable and when connecting other equipment.**

5.1 Unpacking the Machine

Carefully remove the machine from the packaging, we recommend you retain the packaging until the machine has been fully installed and tested in case it has been damaged in transit and has to be returned to the re-seller.

5.2 Location

Be sure to locate the welder according to the following guidelines:

In areas, free from moisture and dust.

Ambient temperature between 0-40°C.

In areas, free from oil, steam and corrosive gases.

In areas, not subjected to abnormal vibration or shock.

In areas not exposed to direct sunlight or rain.

Place at a distance of 12" (300 mm) or more from walls or similar that could restrict natural airflow for cooling.

5.3 Input and Grounding Connection

WARNING

Before starting the installation, check that your power supply is adequate for the voltage, amperage, phase, and frequency specified on the Machine nameplate.

Only operate from an AC power supply, the input voltage must match that on the machine rating plate.

Have a qualified electrician connect the input plug. For long runs over 30m, larger copper wires should be used. The green/yellow wire in the input cable connects to the frame of the machine. This ensures proper grounding of the machine when the machine plug is inserted into the receptacle.

5.4 MIG Welding Torch Setup

The welder, as shipped from the factory, is connected for electrode positive (+) polarity. This is the normal polarity for MIG welding with gas.

5.4.1 Changing Feed Roll Sets

1. Turn off the power source.
2. Release the pressure arm by rotating the pressure adjusters down towards the open side of the machine.
3. Unscrew the knurled metal thumb screws, remove the washers, then remove the feed rolls from the drive rollers.
4. Make sure the wire size selected matches the wire size to be used. The wire size marked on the side of the feed roll refers to the groove closest to it. Assemble the feed roll onto the drive roller with the side showing the required size facing into the wire feed unit. Note the outward facing side of the feed roll does not show the feed roll size loaded.
5. Replace the washers and knurled metal thumb screws, push the pressure arm back down and rotate the pressure adjusters back into position.

NOTE: Be sure that the torch liner and contact tip are also sized to match the selected wire size.

5.4.2 Welding Wire Installation

Open the Wire Drive Compartment Door

6. Unscrew the plastic retaining wheel from the end of the spool holder shaft.
7. Position the wire spool so that it will rotate in a direction when feeding so as to be de-reeled from the bottom of the coil.
8. Slide the wire spool all the way onto the shaft and refit the plastic retaining nut.

Note:- there is a friction brake on the reel hub assembly to prevent the wire spool over running when welding stops ensure the this is slackened to the minimum setting. It can be adjusted by means of the nut visible when the plastic nut is removed.

9. Turn the Spool until the free end of the electrode is accessible. While securely holding the electrode, cut off the bent end and straighten the first 100mm. (If the electrode is not properly straightened, it may not feed properly through the wire drive system. Manually feed the wire from the wire reel and through the wire guide and then over the top of the wire feed roll (ensure the pressure arm is in its raised position.)
10. Continue to feed the wire through the outlet guide until 20mm of wire is protruding from the front of the machine torch connector.
11. Reposition the adjustable pressure arm to its original position to apply pressure. Adjust pressure as necessary.

Note the pressure arm should be adjusted in order to give the minimum amount of pressure on the wire to allow reliable feeding,

5.4.3 Torch Installation

Your Parweld MIG/MAG Welding Torch has been supplied ready to weld. It has been supplied with the standard consumables denoted in the product brochure.

To connect the torch to the power source:-

1. Remove the tip adaptor and contact tip
2. Inch the wire from the exit of the wire guide on the feed unit as Figure 1 (page 10). Ensure that it does not short out on any machine panels.
3. Carefully slide the electrode wire into the torch liner and slowly locate the torch gun plug body into the feed unit central connector and tighten the gun plug nut as Figure 2 (page 10).

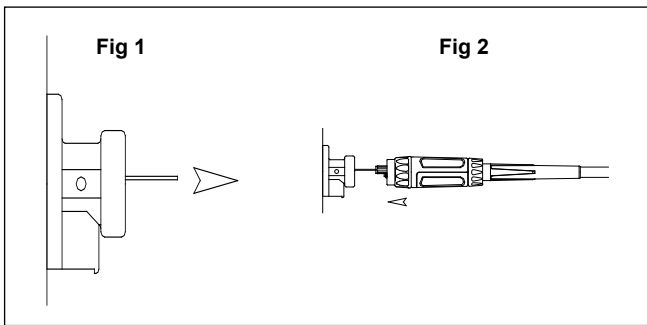

Note; To aid the initial location of a new torch and to prevent damage to the gas nipple O-ring a very light application of grease to the O Ring is beneficial.

4. Keeping the torch as straight as possible, use the inching button (13) to feed the electrode wire 50mm from the end of the liner conduit.
5. Once the electrode wire has stopped, refit the tip adaptor, diffuser, contact tip and gas nozzle.
6. Trim the electrode wire to within 5mm of the face of the nozzle, this will facilitate jolt free arc initiation.
8. An inexpensive flow meter is available from Parweld reference 806001.

5.4.4 Work Return Lead Connection

Insert the work return lead connector into the Negative Twist lock receptacle on the front panel of the power source and twist it clockwise until tightly secured.

Connect the earth clamp to the work piece as close as possible to the point to be welded and ensure that a good electrical connection is created to bare metal.

5.4.5 Shielding Gas Connection

1. Using the gas hose supplied connect the hose to the gas inlet connection on the rear of the machine using the connector supplied.
2. Connect the opposite end of the gas hose to the output connection of a gas regulator capable of supplying the correct gas flow for the welding operation.
3. Press the gas test button (22) and check the gas flow is adequate for your application.

Note The gas cylinder should be secured to ensure it cannot fall.

6.0 Setting the Machine for Welding

6.1 MIG Welding

6.1.1 MIG SYN Synergic MIG Welding Allows Simple and Rapid Setup.

Select MIG on the front panel of the power source using the push button, to toggle through the functions. Once MIG is selected the adjustment is from the wire feeder screen.



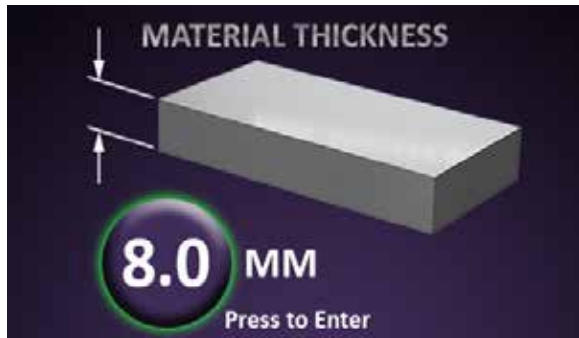

Operating screen (MIG SYN)

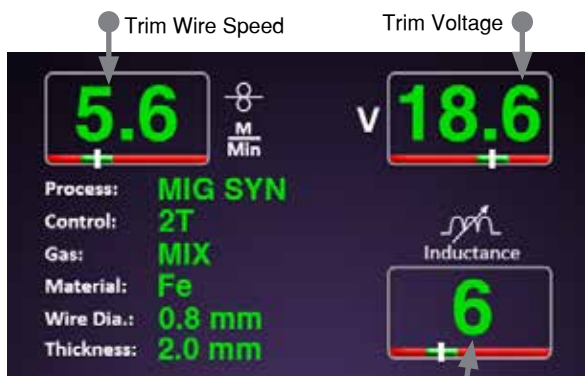

In manual mode you can adjust the parameters using the controls indicated.



6.1.2 MIG MAN Manual MIG welding setup

Follow the screen prompts to complete the machine setup.
Example setting.



6.1.3 Feeding Wire Electrode

1. When triggering, the electrode and drive mechanism are electrically "LIVE" relative to work and ground and remain "LIVE" several seconds after the torch trigger is released.

WARNING

When using an open arc process, it is necessary to use correct eye, head, and body protection.

2. Position wire over joint. The end of the wire may be lightly touching the work.
3. Lower welding helmet, operate torch trigger, and begin welding. Hold the torch so the contact tip to work distance is about 3/8" (10 mm).
4. To stop welding, release the torch trigger and then pull the torch away from the work after the arc goes out.
5. When no more welding is to be done, close valve on gas cylinder (if used), momentarily operate torch trigger to release gas pressure and turn off the machine.

6.1.4 Optimising Weld Parameters (Manual Mode)

NOTE These settings are guidelines only. Material and wire type, joint design, fit up, position, shielding gas, etc. Affect settings. Produce test welds to be sure they comply to specifications.

Material thickness determines weld parameters.

1. Convert Material Thickness to Amperage (A) (0.025mm = 1 Amp) 3.2mm = 125 A
2. Select Wire Size

Amperage Range	Wire Size
40 - 145 A	0.8 mm
50 - 180 A	1.0 mm
3. Select Wire Speed (Amperage)

Wire Size	Feed speed
0.8 mm	0.05m/min per Amp
1.0 mm	0.04m/min per Amp

So based on 3.2 mm material thickness amperage should be 125A if using 1.0mm wire then the wire feed speed should be $0.04 \times 125 = 5\text{m/min}$

Wire speed (amperage) controls weld penetration

4. Select Voltage. Voltage controls height and width of weld bead.

Low Voltage: wire stubs into work

High Voltage: arc is unstable (spatter)

Set voltage midway between high/low voltages.

And then fine tune accordingly

6.1.5 Optimising Weld Parameter (Synergic Mode).

In synergic mode you may wish to trim the voltage (4) to optimize the welding process, you can rotate the voltage control left or right to decrease or increase the preset welding voltage. You can also adjust the inductance (11) to change the hardness of the arc.

6.1.6 Burn Back

The amount of wire stick out at the end of the torch after welding can be adjusted by using the burn back control in the help menu.

6.1.7 Pre and Post Gas Setting

The amount of Pre and post Gas can be set using the gas function in the Help menu

6.1.8 Aluminium Welding

1. Change inlet guide to a sleeved one to protect the wire. Remove the MIG torch, remove the securing screw to release the brass guide, and push the guide out through the machine connection block.
2. Slide the sleeved inlet guide onto the end of the liner in the torch and push back into the machine.
3. Replace the small piece of steel liner assembled to the left side of the wire feed unit with a piece of Teflon liner.

6.1.9 2T - 4T trigger

IN 2T mode, you press and hold in the trigger to weld and release at the end of the weld. In 4T mode press an release the trigger to start. Press and release again to stop.

6.2 MMA Welding

- 6.2.1 Unthread the MIG welding wire from the MIG Torch and remove the spool or secure the wire to prevent un-spooling.

6.2.2 Torch and Work Lead Connections

Connect the electrode lead to the positive terminal and the work lead to the negative terminal.

6.2.3 Operation

Select the operating mode on the front panel to MMA (10)

Using the optional electrode holder, clamp a welding electrode in the holder and adjust the welding amperage on the power source front panel so that it is approximately 40A per mm diameter of electrode e.g. 3.2mm electrode requires $3.2 \times 40A = 128A$. Strike the arc by stroking the electrode on the work piece. And lift away when you wish to break the arc.

6.2.4 Arc Force

The Arc Force can be adjusted between 0 and 10 using the control knob (12). The V meter will display the OCV or welding voltage after adjustment

6.3 TIG Welding Operation

To begin TIG welding operation:

NB: this machine only operates in DC Lift TIG mode and therefore NOT suitable for TIG welding aluminium.

1. Unthread the MIG welding wire from the MIG Torch and remove the spool or secure the wire to prevent un-spooling.
2. Attach the Negative power outlet (14)
3. Connect the Work Return Lead to the + Power Outlet (13).
4. Connect the Gas Hose & Regulator to a suitable gas source (for TIG operation this will be Pure Argon and may differ to what was being used for the MIG process)
5. Use the function selection control (10) to select the TIG function
6. Adjust the Amperage control (11) to the desired power output

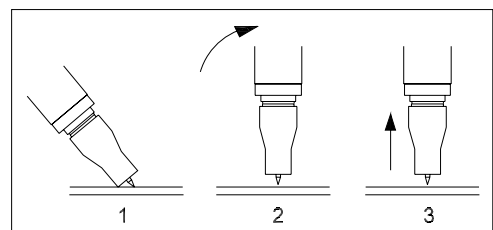

(as a guide only 1.0mm material thickness = 30amps of welding Current)

- You are now ready to begin, switch on the gas. Lightly touch the Tungsten Electrode to the work piece and draw the torch away extending the arc to around 3-5mm

7.0 Fault finding

7.1 MIG WELDING PROBLEMS

Problem	Cause/Corrective Action
Porosity - small cavities or holes Resulting from gas pockets in weld metal.	<p>Inadequate shielding gas coverage. Check for proper gas flow rate.</p> <p>Remove spatter from gun nozzle.</p> <p>Check gas hoses for leaks.</p> <p>Eliminate drafts near welding arc.</p> <p>Place nozzle 6-13 mm from work piece Hold gun near bead at end of weld until molten metal solidifies.</p> <p>Wrong gas. Use welding grade shielding gas; change to different gas.</p> <p>Dirty welding wire. Use clean, dry welding wire. Eliminate pickup of oil or lubricant on welding wire from feeder or liner.</p> <p>Work piece dirty. Remove all grease, oil, moisture, rust, paint, coatings, and dirt from work surface before welding. Use a more highly deoxidizing welding wire (contact supplier).</p> <p>Welding wire extends too far out of nozzle.</p> <p>Be sure welding wire extends not more than 13 mm beyond nozzle.</p>
Incomplete fusion to base metal	<p>Work piece dirty. Remove all grease, oil, moisture, rust, paint, coatings, and dirt from work surface before welding.</p> <p>Insufficient heat input. Select higher voltage range and/or adjust wire feed speed.</p> <p>Improper welding technique. Place stringer bead in proper locations) at joint during welding.</p> <p>Adjust work angle or widen groove to access bottom during welding.</p>

TIG WELDING GUIDE RANGES

Electrode diameter	DC current (amps)
0.040" (1.0mm)	30 – 60
1/16" (1.6mm)	60 – 115
3/32" (2.4mm)	100 – 165

TUNGSTEN ELECTRODE TYPES

Electrode type	Welding application	Colour code
Thoriated 2%	DC welding of mild steel, stainless steel and copper. Excellent arc starting, long life, high current carrying capacity.	RED
Ceriated 2%	DC welding of mild steel, stainless steel, copper, aluminium, their alloys longer life, more stable arc, easier starting, wider current range, narrower more concentrated arc	GREY

GUIDE FOR SELECTING FILLER WIRE DIAMETER

Filler wire diameter	DC current range
1/16" (1.6 mm)	20 - 90
3/32" (2.4 mm)	65 - 115
1/8" (3.2 mm)	100 - 165
3/16" (4.8 mm)	200-350

The filler wire diameter specified is a guide only, other diameter wires may be used according to the welding application.

SHIELDING GAS SELECTION

Alloy	Shielding gas
Aluminium & alloys	Pure Argon
Carbon steel	Pure Argon
Stainless steel	Pure Argon
Nickel alloy	Pure Argon
Copper	Pure Argon
Titanium	Pure Argon

Problem	Cause/Corrective Action
Incomplete fusion to base metal	Adjust work angle or widen groove to access bottom during welding. Momentarily hold arc on groove side walls when using weaving technique. Keep arc on leading edge of weld puddle. Use correct gun angle of 0 to 15 degrees.
Excessive Penetration – weld metal melting through base metal and hanging underneath weld.	Excessive heat input. Select lower voltage range and reduce wire feed speed. Increase travel speed.
Lack Of Penetration - shallow Fusion between weld metal and Base metal.	Improper joint preparation. Material too thick. Joint preparation and design must provide access to bottom of groove while maintaining Proper welding wire extension and arc characteristics. Improper weld technique. Maintain normal gun angle of 0 to 15 degrees to achieve maximum penetration. Keep arc on leading edge of weld puddle. Ensure welding wire extends not more than 13 mm beyond nozzle. Insufficient heat input. Select higher wire feed speed and/or select higher voltage range. Reduce travel speed.
Burn-Through - weld metal melting Completely through base metal Resulting in holes where no metal remains.	Excessive heat input. Select lower voltage range and reduce wire feed speed. Increase and/or maintain steady travel speed.
Excessive Spatter - scattering of Molten metal particles that cool to solid form near weld bead.	Wire feed speed too high. Select lower wire feed speed. Voltage too high. Select lower voltage range. Electrode extension (stick out) too long. Use shorter electrode extension (sick out). Work piece dirty. Remove all grease, oil, moisture, rust, paint, undercoating, and dirt from work surface before welding. Insufficient shielding gas at welding arc. Increase flow of shielding gas at regulator/flow meter and/or prevent drafts near welding arc. Dirty welding wire. Use clean, dry welding wire. Eliminate pickup of oil or lubricant on welding wire from feeder or liner.
Wire feed unit operates but no gas flow .	Gas cylinder empty Gas regulator closed Faulty solenoid Restriction in torch cables
Wire feed unit operates, but does not feed	Insufficient drive roll pressure Incorrect drive rolls Excessive wire spool brake tension

Problem	Cause/Corrective Action
Wire feed unit operates, but does not feed	Incorrect liner Blocked liner Bird nesting Burn back
Bird nesting	Excessive feed roll pressure Incorrect or blocked liner Incorrect contact tip size Contact tip overheating Restriction in torch cable Misaligned drive rolls or wire guides Excessive cable kinkage
Burn back	Improper voltage setting Improper stick out Erratic wire feed Incorrect or blocked liner Contact tip overheating Excessive cable kinking Adjust the burn back control correctly
Erratic Wire Feeding or Arc	Improper drive roll tension Improper drive roll size Worn drive rolls Incorrect or blocked liner Incorrect wire guide size Misaligned drive rolls or wire guide Gaps at liner or wire guide junctions Incorrect contact tip size Contact Tip overheating Spatter adhesion on exit geometry of tip bore Excessive cable kinkage Poor earth or cable connections Weld joint area dirty
Red temperature light illuminates	Power source has over heated leave the machine running to allow it to cool down. Ensure entry and exit vents on machine are clear and machine has a good supply of cooling air. Reduce operating duty cycle and or amperage.

7.2 MMA WELDING PROBLEMS

Description	Possible cause	Remedy
Gas pockets or voids in weld metal (porosity)	(a) Electrodes are damp (b) Welding current is too high. (c) Surface impurities such as oil, grease, paint, etc	(a) Dry electrodes before use (b) Reduce welding current (c) Clean joint before welding
Crack occurring in weld metal soon after solidification.	(a) Rigidity of joint. (b) Insufficient throat thickness. (c) Cooling rate is too high.	(a) Redesign to relieve weld joint of severe stresses or use crack resistance electrodes. (b) Travel slightly slower to allow greater build up in throat. (c) Preheat plate and cool slowly.
A gap is left by failure of the weld metal to fill the root of the weld	(a) Welding current is too low. (b) Electrode too large for joint. (c) Insufficient gap (d) Incorrect sequence	(a) Increase welding current (b) Use smaller diameter electrode. (c) Allow wider gap (d) Use correct build-up sequence
Portions of the weld run do not fuse to the surface of the metal or edge of the joint.	(a) Small electrodes used on heavy cold plate (b) Welding current is too low (c) Wrong electrode angle (d) Travel speed of electrode is too high (e) Scale or dirt on joint surface	(a) Use larger electrodes and preheat the plate (b) Increase welding current (c) Adjust angle so the welding arc is directed more into the base metal (d) Reduce travel speed of electrode (e) Clean surface before welding.
Non-metallic particles are trapped in the weld metal (slag inclusion).	(a) Non-metallic particles may be trapped in undercut from previous run (b) Joint preparation too restricted (c) Irregular deposits allow slag to be trapped. (d) Lack of penetration with slag trapped beneath weld bead. (e) Rust or mill scale is preventing full fusion. (f) Wrong electrode for position in which welding is done.	(a) If bad undercut is present, clean slag out and cover with a run from a smaller diameter electrode. (b) Allow for adequate penetration and room for cleaning out the slag (c) If very bad, chip or grind out Irregularities (d) Use smaller electrode with sufficient current to give adequate penetration. adequate penetration. Use suitable tools to remove all slag from corners (f) Use electrodes designed for position in which welding is done, otherwise proper control of slag is difficult.

7.3 TIG WELDING PROBLEMS

Weld quality is dependent on the selection of the correct consumables, maintenance of equipment and proper welding technique.

Description	Possible Cause	Remedy
Excessive bead build up or poor penetration or poor fusion at edges of weld	Welding current is too low	Increase weld current and/or faulty joint preparation
Weld bead too wide and flat or undercut at edges of weld or excessive burn through	Welding current is too high	Decrease weld current
Weld bead too small or insufficient penetration or ripples in bead are widely spaced apart	Travel speed too fast	Reduce travel speed
Weld bead too wide or excessive bead build up or excessive penetration in butt joint	Travel speed too slow	Increase travel speed
Uneven leg length in fillet joint	Wrong placement of filler rod	Re-position filler rod
Electrode melts when arc is struck	Electrode is connected to the '+' terminal	Connect the electrode to the '-' terminal
Dirty weld pool	(a) Electrode contaminated through contact with work piece or filler rod material (b) Gas contaminated with air	(a) Clean the electrode by grinding off the contaminates (b) Check gas lines for cuts and loose fitting or change gas cylinder
Electrode melts or oxidizes when an arc is struck	(a) No gas flowing to welding region (b) Torch is clogged with dust (c) Gas hose is cut (d) Gas passage contains impurities (e) Gas regulator is turned off (f) Torch valve is turned off (g) The electrode is too small for the welding current	(a) Check the gas lines for kinks or breaks and gas cylinder contents (b) Clean torch (c) Replace gas hose (d) Disconnect gas hose from torch then raise gas pressure to blow out impurities. (e) Turn on (f) Turn on (g) Increase electrode diameter or reduce the welding current
Poor weld finish	Inadequate shielding gas	Increase gas flow or check gas line for gas flow problems

Description	Possible Cause	Remedy
Arc flutters during TIG welding	(a) Tungsten electrode is too large for the welding current. (b) Absence of oxides in the Weld pool.	(a) Select the right size electrode. Refer to basic TIG welding guide. (b) Refer basic TIG welding guide for ways to reduce arc flutter.
Welding arc cannot be established	(a) Work clamp is not connected to the work piece or the work/torch leads are not connected to the machine (b) Torch lead is disconnected (c) Gas flow incorrectly set, cylinder empty or the torch valve is off	a) Connect the work clamp to the work piece or connect the work/torch leads to the right welding terminals. (b) Connect it to the ' ' terminal. (c) Select the right flow rate, change cylinders or turn torch valve on.
Arc start is not smooth	(a) Tungsten electrode is too large for the welding current . (b) The wrong electrode is being used for the welding job. (c) Gas flow rate is too high. (d) Incorrect shielding gas is being used. (e) Poor work clamp connection to work piece	(a) Select the right size electrode (b) Select the right electrode type. Refer to basic TIG welding guide (c) Select the correct rate for the welding job. Refer to basic TIG welding guide (d) Select the right shielding gas. Refer to basic TIG welding guide (e) Improve connection to work piece

7.4 POWER SOURCE PROBLEMS

Description	Possible cause	Remedy
The welding arc cannot be established	(a) The primary supply voltage has not been switched on (b) The welding power source switch is switched off (c) Loose connections internally	(a) Switch on the primary supply voltage. (b) Switch on the welding power source. (c) Have a qualified service engineer repair the connection.
Maximum output welding current cannot be achieved with nominal mains supply voltage	Defective control circuit	Have a qualified service engineer inspect then repair the welder.

Description	Possible cause	Remedy
Welding current reduces when welding	Poor work lead connection to the work piece	Ensure that the work lead has a reliable electrical connection to the work piece.
Gas pockets or voids in weld metal (porosity)	(a) Electrodes are damp (b) Welding current is too high. (c) Surface impurities such as oil, grease, paint, etc	(a) Dry electrodes before use (b) Reduce welding current (c) Clean joint before welding
Gas pockets or voids in weld metal (porosity)	(a) Electrodes are damp (b) Welding current is too high. (c) Surface impurities such as oil, grease, paint, etc	(a) Dry electrodes before use (b) Reduce welding current (c) Clean joint before welding

ROUTINE MAINTENANCE

The only routine maintenance required for the power supply is a thorough cleaning and inspection, with the frequency depending on the usage and the operating environment.

Warning

Disconnect primary power at the source before removing the cover. Wait at least two minutes before opening the cover to allow the primary capacitors to discharge.

To clean the unit, remove the screws securing the outer cover, lift off the outer cover and use a vacuum cleaner to remove any accumulated dirt and dust. The unit should also be wiped clean, if necessary; with solvents that are recommended for cleaning electrical apparatus.

8.0 Accessories

8.1 Feed Rolls



Part No.	Groove	Wire Sizes	Wires
DR5V0810	Plain V	0.8 - 1.0	Fe, Ss
DR5V0910	Plain V	0.9 - 1.0	Fe, Ss
DR5V1012	Plain V	1.0 - 1.2	Fe, Ss
DR5K0810	Knurled V	0.8 - 1.0	FC
DR5K1012	Knurled V	1.0 - 1.2	FC
DR5U0910	Plain U	0.9 - 1.0	Al
DR5U1012	Plain U	1.0 - 1.2	Al

8.2 Torch Spares

Stock Code	Description
CKE503	Electrode Holder with 3m Lead
CKC503	Earth Lead 3m with Clamp
PRO26-12-2IX	Valved TiG Torch
WP17AK	Tig Spares Kit in Plastic Case

8.3 Gas Equipment

Everyday Gas Regulators – 300 BAR

Single Stage

Features

Flow rate up to 96m³/h (3389 ft³/h)

- Full 300 bar capability
- Outlet pressure indicated on the bonnet
- Bottom entry design suited for top outlet cylinder valves

Fittings

- Fitted with standard 3/8" BSP outlet
- Fitted with 5/8" BSP inlet connections



Stock Code	Description	Maximum Outlet Pressure
E700140	Argon Preset Regulator	3.0 Bar
E700141	Argon Indicator Regulator	3.0 Bar
E700113	1 Gauge Argon	30 lpm flow
E700123	2 Gauge Argon	30 lpm flow

8.4 Flow Meters

Features

- Designed from brass bar whilst the tube and cover are moulded from high quality polycarbonate to ensure high impact resistance and clarity
- Calibrated to operate at an inlet pressure of 30PSI
- Sensitive needle valve provides easy adjustment and the downward facing outlet connection eliminates hose kinking.

Fittings

- Fitted with standard 3/8" BSP inlet and outlet connections



Stock Code	Description
706100	Flow Meter Mixed Gas 15 lpm (TIG)
706101	Flow Meter Mixed Gas 25 lpm (MIG)

9.0 Torch Schematic - XP8 400A

Air Cooled MIG Welding Torch

400a, 12KW, Mixed Gas (80/20) @ 80% Duty cycle, EN60974 -7 .045"- 3/32"/1.2mm to 2.4mm Wires

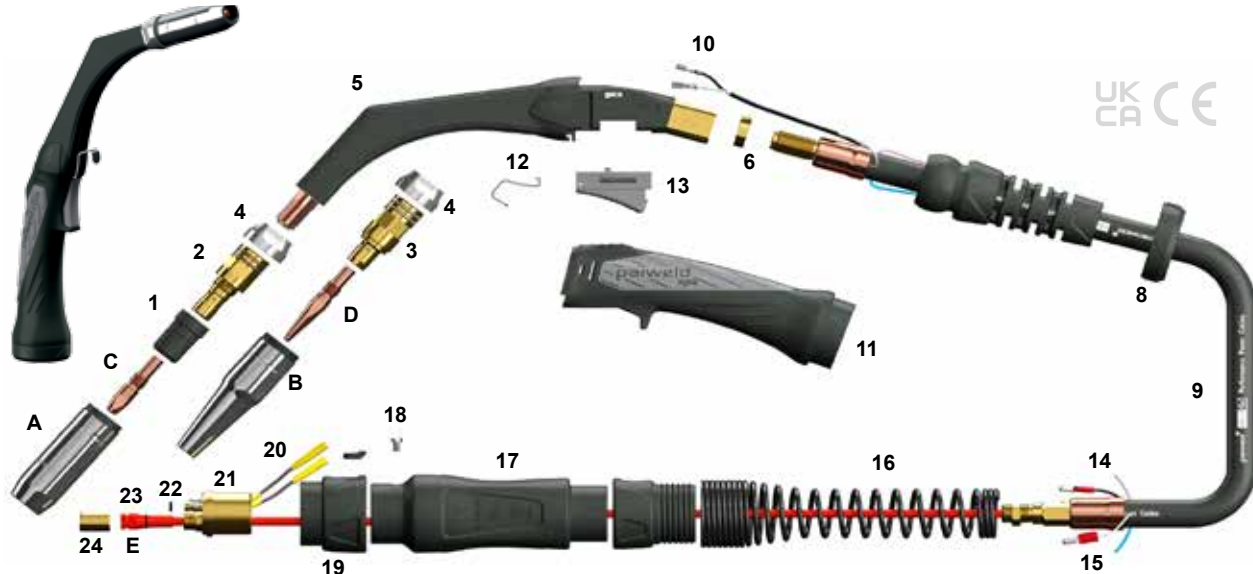

Model

Stock Code	Description
XP400A-30E	Welding Torch Package c/w Euro Fitting x 3m
XP400A-40E	Welding Torch Package c/w Euro Fitting x 4m
XP400A-50E	Welding Torch Package c/w Euro Fitting x 5m

Nozzles

Stock Code	Description
A XP3002-13	Tapered Nozzle 1/2"/13mm
XP3002-16*	Conical Nozzle 5/8"/16mm
XP3002-16L	Conical Nozzle 5/8"/16mm Extended
XP3002-19	Cylindrical Nozzle 3/4"/19mm
XP3002-19L	Cylindrical Nozzle 3/4"/19mm Extended
B XP3002-10T	Long Tapered Nozzle 3mm/1/8" 10mm/3/8"

Contact Tips

Stock Code	Description
C XP3003-10A	Contact Tip .040"/1.0mm M10 CuCrZr Al
XP3003-10A	Contact Tip .040"/1.0mm M10 CuCrZr
XP3003-12*	Contact Tip .030"/0.8mm M8 CuCrZr
XP3003-12A	Contact Tip .045"/1.2mm M10 CuCrZr Al
XP3003-13	Contact Tip .052"/1.3mm M10 CuCrZr
XP3003-14	Contact Tip .055"/1.4mm M10 CuCrZr
XP3003-16	Contact Tip 1/16"/1.6mm M10 CuCrZr
XP3003-18	Contact Tip .071"/1.8mm M10 CuCrZr
XP3003-20	Contact Tip 5/64"/2.0mm M10 CuCrZr
XP3003-24	Contact Tip 3/32"/2.4mm M10 CuCrZr
D XP3003-10T	Tapered Contact Tip 1.0mm/.040" CuCrZr
XP3003-12T	Tapered Contact Tip 1.2mm/.045" CuCrZr
XP3003-13T	Tapered Contact Tip 1.3mm/.052" CuCrZr
XP3003-14T	Tapered Contact Tip 1.4mm/.055" CuCrZr
XP3003-16T	Tapered Contact Tip 1.6mm/1/16" CuCrZr
XP3003-18T	Tapered Contact Tip 1.8mm/.071" CuCrZr
XP3003-20T	Tapered Contact Tip 2.0mm/5/64" CuCrZr
XP3003-24T	Tapered Contact Tip 2.4mm/3/32" CuCrZr

Liners

Stock Code	Description
E XP3524-12-30*	Steel Liner .040-.045"/1.0-1.2mm x 3m/10ft
XP3524-12-40*	Steel Liner .040-.045"/1.0-1.2mm x 4m/13ft
XP3524-12-50*	Steel Liner .040-.045"/1.0-1.2mm x 5m/16ft
XP3524-16-30	Steel Liner .045-.063"/1.2-1.6mm x 3m/10ft
XP3524-16-40	Steel Liner .045-.063"/1.2-1.6mm x 4m/13ft
XP3524-16-50	Steel Liner .045-.063"/1.2-1.6mm x 5m/16ft
XP4024-24-30	Steel Liner .080-.095"/2.0-2.4mm x 3m/10ft
XP4024-24-40	Steel Liner .080-.095"/2.0-2.4mm x 4m/13ft

Liners

Stock Code	Description
XP4024-24-50	Steel Liner .080-.095"/2.0-2.4mm x 5m/16ft
NI XP3524PC-16-30	Poly-Copper Liner .045-.063"/1.2-1.6mm x 3m/10ft
XP3524PC-16-40	Poly-Copper Liner .045-.063"/1.2-1.6mm x 4m/13ft
XP3524PC-16-50	Poly-Copper Liner .045-.063"/1.2-1.6mm x 5m/16ft
XP4024PC-20-30	Poly-Copper Liner .063-.080"/1.6-2.0mm x 3m/10ft
XP4024PC-20-40	Poly-Copper Liner .063-.080"/1.6-2.0mm x 4m/13ft
XP4024PC-20-50	Poly-Copper Liner .063-.080"/1.6-2.0mm x 5m/16ft
XP3524PS-16-30	Poly-Steel Liner .045-.063"/1.2-1.6mm x 3m/10ft
XP3524PS-16-40	Poly-Steel Liner .045-.063"/1.2-1.6mm x 4m/13ft
XP3524PS-16-50	Poly-Steel Liner .045-.063"/1.2-1.6mm x 5m/16ft
XP4024PS-20-30	Poly-Steel Liner .063-.080"/1.6-2.0mm x 3m/10ft
XP4024PS-20-40	Poly-Steel Liner .063-.080"/1.6-2.0mm x 4m/13ft
XP4024PS-20-50	Poly-Steel Liner .063-.080"/1.6-2.0mm x 5m/16ft

Components

* Denotes Standard Build

Stock Code	Description
1 XP3004B*	Diffuser-Moulded c/w Ceramic Insert-M10 Head
NI XP3004C	Diffuser-Ceramic-M10 Head
2 XP3505*	Head Assembly-M10 Tips
3 XP3505T	Head Assembly-M10 Tapered Tips
NI XP3506B	Heat Shield-Moulded-M10 Head
4 XP3506A*	Aluminium Heat Shield-M10 Head
5 XP4001	Swan Neck
6 XP3507	Lock Nut M14
7 XP3088	Cable Support
8 XP3009	Handle Lock Nut
9 XP4010-30	Hyperflex™ Cable Assembly x 3m/10ft
XP4010-40	Hyperflex™ Cable Assembly x 4m/13ft
XP4010-50	Hyperflex™ Cable Assembly x 5m/16ft
10 XP2011	Cable Terminal Female
11 XP2112	Handle Kit c/w Lock Nut and Support
12 XP2013	Hanger Hook
13 XP2014	Trigger Assembly
14 XP2015	Cable Terminal Male
15 XP2016	Lock Nut M12
16 XP2017	Cable Support
17 XP2018	Air Cooled Gun Plug Housing c/w Nut
18 XP2019	Gun Plug Screw
19 XP2020	Gun Plug Nut
20 Spring Pin 2	Spring Pin Assembly
21 XP2022	Gun Plug Body c/w Spring Pins
22 XP2023	Euro Body 'O' Ring
23 XP2025	Liner Nipple 'O' Rings
24 XP2026	Liner Retaining Nut

9.1 Torch Schematic - XP8 450W

Water Cooled MIG Welding Torch

450A, 15.8KW, Mixed Gas (80/20) @ 100% Duty Cycle, EN60974 -7 .040"- 3/32"/1.0mm to 2.4mm Wires

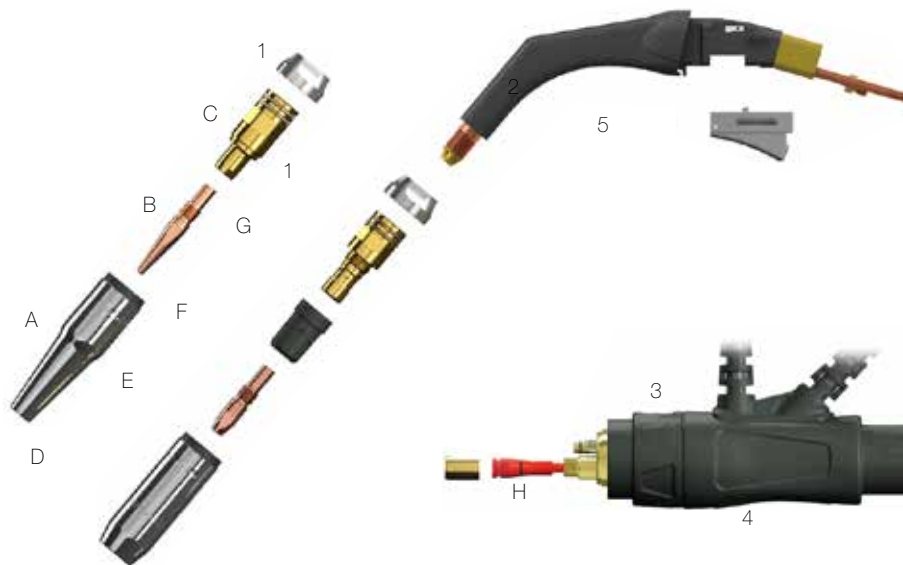

STOCK CODE	DESCRIPTION
XP450W-30E	Torch Package c/w Euro Fitting x 3m
XP450W-40E	Torch Package c/w Euro Fitting x 4m
XP450W-50E	Torch Package c/w Euro Fitting x 5m

STOCK CODE	DESCRIPTION
1 XP3506A*	Aluminium Heat Shield-M10 Head
NI XP3506B	Heat Shield-Moulded-M10 Head
2 XP4501	Swan Neck
3 XP2020	Gun Plug Nut
4 XP3240	Water Cooled Housing c/w Supports
5 XP2014	Trigger

Liners	
See page 42 for full range	
STOCK CODE	DESCRIPTION
XP3524-12-30*	Steel 1.0-1.2mm (.040-.045") x 3m
XP3524-12-40*	Steel 1.0-1.2mm (.040-.045") x 4m
XP3524-12-50*	Steel 1.0-1.2mm (.040-.045") x 5m
XP3524-16-30	Steel 1.6mm (.063") x 3m
XP3524-16-40	Steel 1.6mm (.063") x 4m
XP3524-16-50	Steel 1.6mm (.063") x 5m
XP4024-24-30	Steel 2.0-2.4mm (.080-.095") x 3m
XP4024-24-40	Steel 2.0-2.4mm (.080-.095") x 4m
XP4024-24-50	Steel 2.0-2.4mm (.080-.095") x 5m
XP2024PC-12-30	Poly-Copper 0.8-1.2mm (.030-.045") x 3m
XP2024PC-12-40	Poly-Copper 0.8-1.2mm (.030-.045") x 4m
XP2024PC-12-50	Poly-Copper 0.8-1.2mm (.030-.045") x 5m
XP3524PC-16-30	Poly-Copper 1.2-1.6mm (.045-.063") x 3m
XP3524PC-16-40	Poly-Copper 1.2-1.6mm (.045-.063") x 4m
XP3524PC-16-50	Poly-Copper 1.2-1.6mm (.045-.063") x 5m
XP4024PC-20-30	Poly-Copper 1.6-2.0mm (.063-.080") x 3m
XP4024PC-20-40	Poly-Copper 1.6-2.0mm (.063-.080") x 4m
XP4024PC-20-50	Poly-Copper 1.6-2.0mm (.063-.080") x 5m
XP3524PS-16-30	Poly-Steel 1.2-1.6mm (.045-.063") x 3m
XP3524PS-16-40	Poly-Steel 1.2-1.6mm (.045-.063") x 4m
XP3524PS-16-50	Poly-Steel 1.2-1.6mm (.045-.063") x 5m
XP4024PS-20-30	Poly-Steel 1.6-2.0mm (.063-.080") x 3m
XP4024PS-20-40	Poly-Steel 1.6-2.0mm (.063-.080") x 4m
XP4024PS-20-50	Poly-Steel 1.6-2.0mm (.063-.080") x 5m

Tapered Nozzles

STOCK CODE	STYLE	BORE
XP3002-10T	Tapered	10mm (3/8")

Tapered Contact Tips

STOCK CODE	WIRE SIZE	MATERIAL
XP3003-10T	1.0mm (.040")	CuCrZr
XP3003-12T	1.2mm (.045")	CuCrZr
XP3003-13T	1.3mm (.052")	CuCrZr
XP3003-14T	1.4mm (.055")	CuCrZr
XP3003-16T	1.6mm (1/16")	CuCrZr
XP3003-18T	1.8mm (.071")	CuCrZr
XP3003-20T	2.0mm (5/64")	CuCrZr
XP3003-24T	2.4mm (3/32")	CuCrZr

Tapered Head Assembly

STOCK CODE	TIP THREAD
XP3505T	M10

Nozzles

XP3002-13	Tapered	13mm (1/2")
XP3002-16	Conical	16mm (5/8")
XP3002-19	Cylindrical	19mm (3/4")

Extended Nozzles

XP3002-16L	Conical Ext	16mm (5/8")
XP3002-19L	Cylindrical Ext	19mm (3/4")

Contact Tips

XP3003-10	1.0mm (.040")	CuCrZr
XP3003-12*	1.2mm (.045")	CuCrZr
XP3003-13	1.3mm (.052")	CuCrZr
XP3003-14	1.4mm (.055")	CuCrZr
XP3003-16	1.6mm (1/6")	CuCrZr
XP3003-18	1.8mm (.071")	CuCrZr
XP3003-20	2.0mm (5/64")	CuCrZr
XP3003-24	2.4mm (3/32")	CuCrZr
XP3003-10A	1.0mm (.040")	CuCrZr, Al
XP3003-12A	1.2mm (.045")	CuCrZr, Al

Diffusers

STOCK CODE	TYPE	HEAD
XP3004B*	Moulded with Ceramic Insert	M10
XP3004C (Ni)	Ceramic	M10
XP3004S (Ni)	Grey	M10

Head Assembly

XP3505*	M10
---------	-----

9.2 Torch Schematic - PRO4400W

Double Cooled Water Cooled MIG Welding Torch

400A CO₂, 350A Mixed Gas @ 100% Duty Cycle, EN60974-7 .030"-.045"/0.8mm to 1.2mm Wires

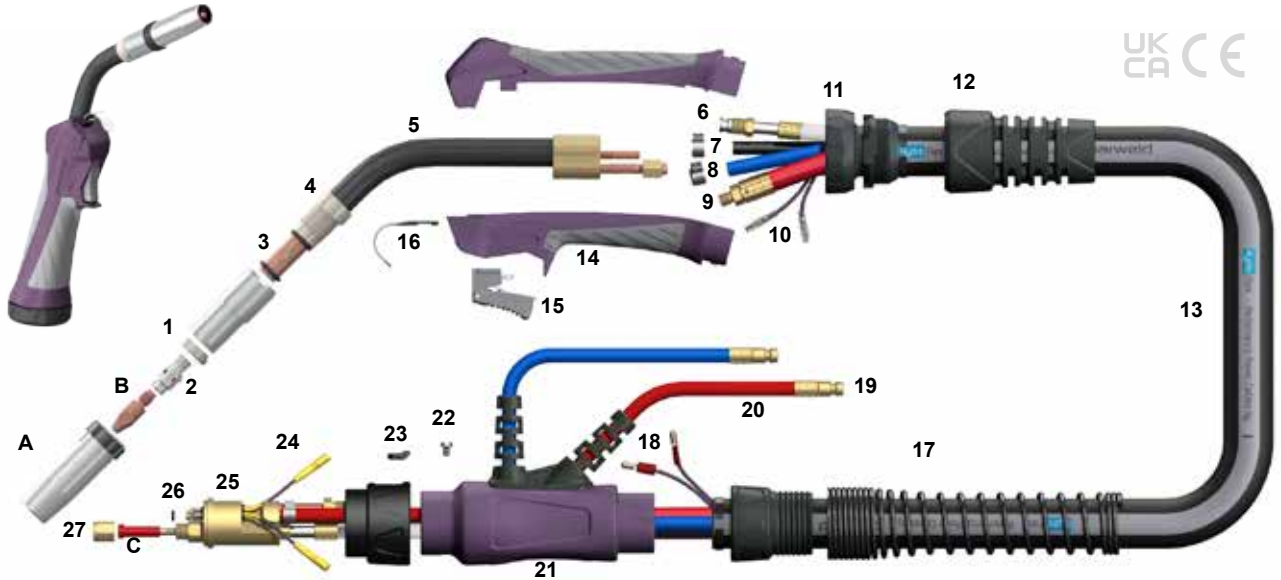

Model

Stock Code	Description
PRO4400-30ER	Welding Torch Package c/w Euro Fitting x 3m/10ft
PRO4400-40ER	Welding Torch Package c/w Euro Fitting x 4m/13ft
PRO4400-50ER	Welding Torch Package c/w Euro Fitting x 5m/16ft

Nozzles

Stock Code	Description
A B4408	Cylindrical Nozzle 3/4"/19mm Bore
B4407*	Conical Nozzle 5/8"/16mm Bore
B4409	Tapered Nozzle 9/16"/14mm Bore

Contact Tips

Stock Code	Description
B B4014-08	Contact Tip .035"/0.8mm M8 ECU
B4014-09	Contact Tip .035"/0.9mm M8 ECU
B4014-10	Contact Tip .040"/1.0mm M8 ECU
B4014-12*	Contact Tip .045"/1.2mm M8 ECU
B4014-16	Contact Tip 1/16"/1.6mm M8 ECU
B4014-10CR	Contact Tip .040"/1.0mm M8 ECU, CR Plated
B4014-12CR	Contact Tip .045"/1.2mm M8 ECU, CR Plated
B4014-10A	Contact Tip .040"/1.0mm M8 ECU, Al
B4014-12A	Contact Tip .045"/1.2mm M8 ECU, Al
B4014-16A	Contact Tip 1/16"/1.6mm M8 ECU, Al
B4015-12	Contact Tip .045"/1.2mm M8 CuCrZr
B4015-16	Contact Tip 1/16"/1.6mm M8 CuCrZr

Liners

Stock Code	Description
E B5033-30	Plain Liner .040"-.045"/1.0-1.2mm x 3m/10ft
B5033-40	Plain Liner .040"-.045"/1.0-1.2mm x 4m/13ft
B5033-50	Plain Liner .040"-.045"/1.0-1.2mm x 5m/16ft
B5034-30*	Plain Liner .045"-1/16"/1.2-1.6mm x 3m/10ft
B5034-40*	Plain Liner .045"-1/16"/1.2-1.6mm x 4m/13ft
B5034-50	Plain Liner .045"-1/16"/1.2-1.6mm x 5m/16ft
B2513-30	Teflon Liner .040"-.045"/1.0-1.2mm x 3m/10ft
B2513-40	Teflon Liner .040"-.045"/1.0-1.2mm x 4m/13ft
B2513-50	Teflon Liner .040"-.045"/1.0-1.2mm x 5m/16ft
B3626-30	Teflon Liner .045"-1/16"/1.2-1.6mm x 3m/10ft
B3626-40	Teflon Liner .045"-1/16"/1.2-1.6mm x 4m/13ft
B3626-50	Teflon Liner .045"-1/16"/1.2-1.6mm x 5m/16ft

Components

* Denotes Standard Build

Stock Code	Description
1 B4403	Isolating Ring
2 B5001	Tip Adaptor 1"/25mm M8
3 B4409	O Ring Pack
4 B4410	Nozzle Seat
5 B4402	Swan Neck
B5024	Water Hose Clamp 9.5mm
6 B5008-30	Outer Liner Assembly x 3m/10ft
B5008-40	Outer Liner Assembly x 4m/13ft
B5008-50	Outer Liner Assembly x 5m/16ft
7 B5013-30	Gas Hose Assembly x 3m/10ft
B5013-40	Gas Hose Assembly x 4m/13ft
B5013-50	Gas Hose Assembly x 5m/16ft
8 B5012-30	Water Inlet Hose Assembly x 3m/10ft
B5012-40	Water Inlet Hose Assembly x 4m/13ft
B5012-50	Water Inlet Hose Assembly x 5m/16ft
9 B5015-30	Power Cable Assembly x 3m/10ft
B5015-40	Power Cable Assembly x 4m/13ft
B5015-50	Power Cable Assembly x 5m/16ft
10 B5010-30	Switch Lead Assembly x 3m/10ft
B5010-40	Switch Lead Assembly x 4m/13ft
B5010-50	Switch Lead Assembly x 5m/16ft
11 B8031	Ball Joint Assembly c/w Clamp
12 B8032	Spring Cable Support c/w Adaptor
13 B5019-30	Canvas Cover Assembly x 3m/10ft
B5019-40	Canvas Cover Assembly x 4m/13ft
B5019-50	Canvas Cover Assembly x 5m/16ft
14 B8594	Pro-Grip Max® Handle Kit
15 B8516	Pro-Grip Max® Trigger
16 B2517	Hanger Hook
17 B8027	Spring Cable Support-Rear
18 B1522	Cable Terminal-Male
19 B5023	Water Hose Nipple
20 B5017	Water Outlet Hose O/Braid
21 B5022	Gun Plug Housing c/w Lock Nut, Hose Supports
22 B1526	Gun Plug Screw
23 B1519	Gun Plug Nut c/w Inset
24 Spring Pin 2	Spring Pin Assembly
25 B5098	Gun Plug Body c/w Spring Pins
26 B1524	Gun Plug 'O' Ring
27 B1525	Liner Nut

10.0 EC Declaration of Conformity

Hereby we declare that the machines as stated below

Type: XTM 405i XTM 505i

Conform to the Low Voltage Directive: 2014/35/EEC
EMC Directive 2014/35/EEC

European standard: EN/IEC 60974-1



This is to certify that the tested sample is in conformity with all provisions of the above detailed EU directives and product standards.

10.1 RoHS Compliance Declaration

Directive 2011/65/EU of the European Parliament
Amended 2015/863 and 2017/2102

Restriction of use of certain hazardous substances in electrical and electronic equipment

Type: XTM 405i XTM 505i

The above listed products are certified to be compliant with the RoHS directive with all homogeneous component parts being controlled to ensure material contents as per the list below.

Cadmium 0.01% by weight
Lead 0.1% by weight
Mercury 0.1% by weight
Hexavalent chromium 0.1% by weight
Polybrominated biphenyl's (pbbs) 0.1% by weight
Polybrominated diphenyl ethers (pbdes) 0.1% by weight

It should be noted that under specific exempted applications, where lead is used as an alloying element the following limits are applied in accordance with the regulations.

Copper and copper alloy parts use less than 4% by weight of each homogeneous component.

Steel and steel alloy parts use less than 4% by weight of each homogeneous component.

Aluminium and aluminium alloy parts use less than 4% by weight of each homogeneous component.

Only dispose off in authorised sites for electrical and electronic waste do not dispose of with general refuse or landfill waste.



10.2 WEEE Statement

WEEE (Waste Electrical & Electronic Equipment) 2012/19/EU

In relation to implementing the legislation, Parweld has established relevant recycling and recovery methods. We have been fully compliant against the marking requirements since August 2005. Parweld is registered in the UK with the Environment agency as detailed below. For WEEE compliance outside the UK please contact your supplier/Importer

Parweld is registered with a compliance scheme Official registration number is WEE/FD0255QV

When your equipment reaches the end of its service life you should return it to Parweld where it will be reconditioned or processed for recycling.

10.3 Statement of Warranty

Limited Warranty:

Parweld Ltd, hereafter, "Parweld" warrants its customers that its products will be free of defects in workmanship or material. Should any failure to conform to this warranty appear within the time period applicable to the Parweld products as stated below, Parweld shall, upon notification thereof and substantiation that the product has been stored, installed, operated, and maintained in accordance with Parweld's specifications, instructions, recommendations and recognized standard industry practice, and not subject to misuse, repair, neglect, alteration, or accident, correct such defects by suitable repair or replacement, at Parweld's sole option, of any components or parts of the product determined by Parweld to be defective.

Parweld makes no other warranty, express or implied. This warranty is exclusive and in lieu of all others, including, but not limited to any warranty of merchantability or fitness for any particular purpose.

Limitation of Liability:

Parweld shall not under any circumstances be liable for special, indirect or consequential damages, such as, but not limited to, lost profits and business interruption. The remedies of the purchaser set forth herein are exclusive and the liability of Parweld with respect to any contract, or anything done in connection therewith such as the performance or breach thereof, or from the manufacture, sale, delivery, resale, or use of any goods covered by or furnished by Parweld whether arising out of contract, negligence, strict tort, or under any warranty, or otherwise, shall not, except as expressly provided herein, exceed the price of the goods upon which such liability is based. No employee, agent, or representative of Parweld is authorized to change this warranty in any way or grant any other warranty.

Purchaser's rights under this warranty are void if replacement parts or accessories are used which in Parweld's sole judgement may impair the safety or performance of any Parweld product.

Purchaser's rights under this warranty are void if the product is sold to purchaser by non-authorized persons.

The warranty is effective for the time stated below beginning on the date that the authorized Distributor delivers the products to the purchaser. Notwithstanding the foregoing, in no event shall the warranty period extend more than the time stated plus one year from the date Parweld delivered the product to the authorized distributor.



Parweld Limited
Bewdley Business Park
Long Bank
Bewdley
Worcestershire
England
DY12 2TZ
Tel: +44 1299 266800
www.parweld.co.uk
info@parweld.co.uk